

Article number: 20475B15B15MT

Description: E+G Two-way clamp mounting - GN 475-B15-B15-MT

Measures

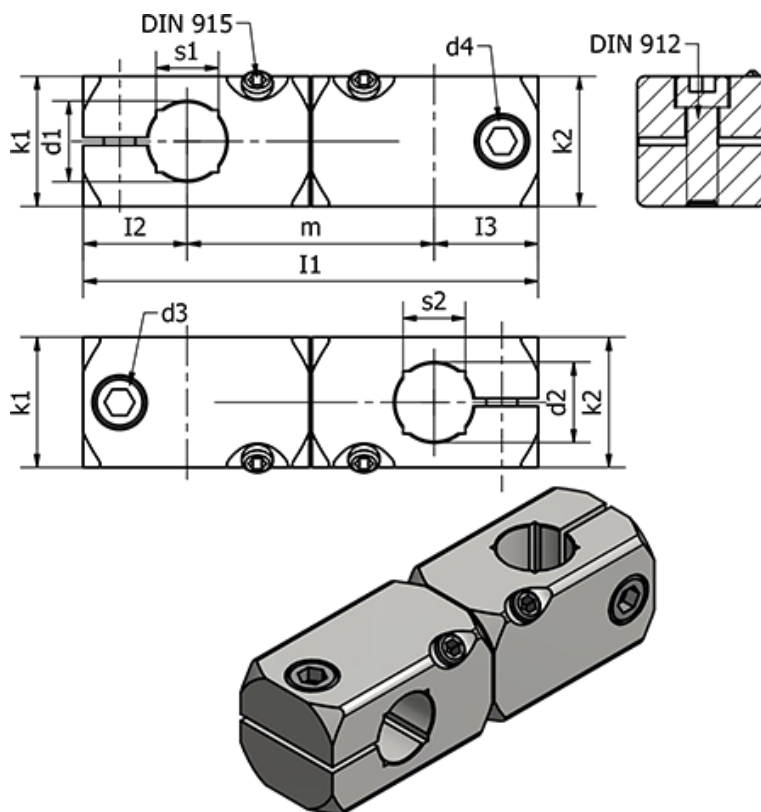

Clamping kit for d3 = GN 511-M6-25

Clamping kit for d4 = GN 511-M6-25

d1 = 15

d2 = 15

d3 = M6

d4 = M6

I1 = 87.5

I2 = 20

I3 = 20

k = 25

k2 = 25

m = 4.5

s1 = 12

s2 = 12

Weight (g) = 113